

Transformer Bobbin Design



ETD54/27/19 Horizontal 11+11 BOBBIN



RoHS / RoHS II Compliant

ETD54/27/19 Horizontal 11+11 BOBBIN

- Material: PET
- Durable construction
- ETD Bobbin Cost: Relative low cost
- Bobbin ETD UL certificate
- Application: Switch power transformer, inductor coil, Filter, etc...
- More than 1,000 kinds of series, and it has a vertical, horizontal, straight pin, SMD and so on.
-

Product Size:

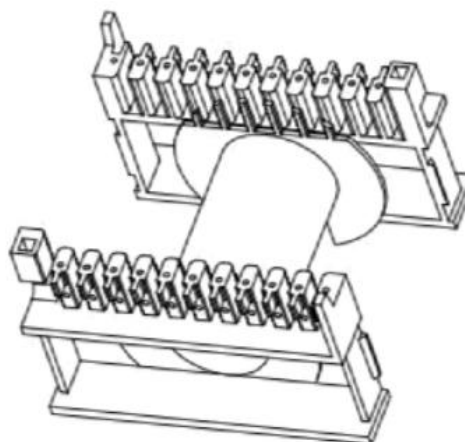
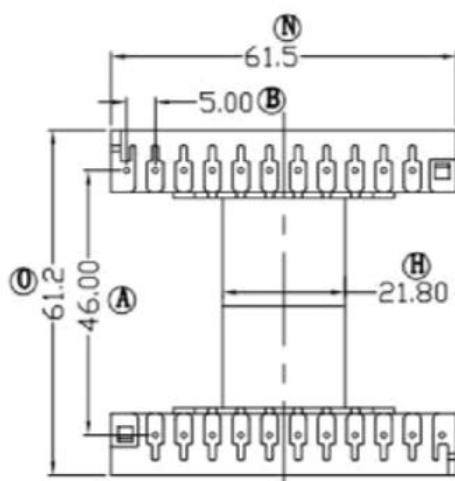
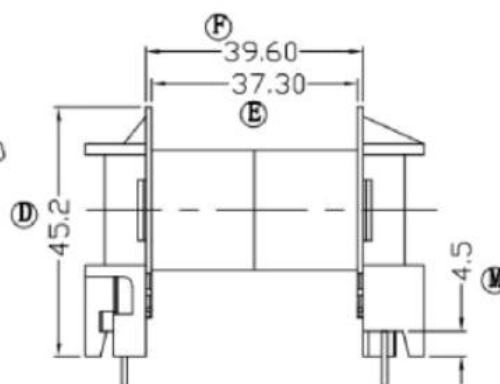
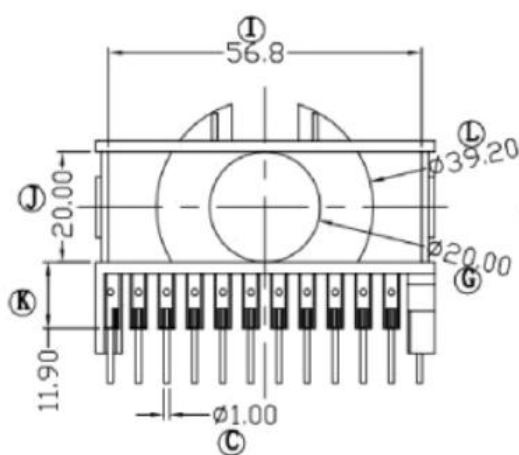

All material meet RoHS Standard

JHCOILS

Shijie town, Dongguan,Guangdong | CN 523290 **Revised:**

Email. info@jhcoils.com

Visit www.JHcoils.com for more design

Transformer Bobbin Design



ETD54/27/19 Horizontal 11+11 BOBBIN



RoHS / RoHS II Compliant

STORAGE AND OPERATIONAL CONDITION:

Storage condition

- Recommended storage conditions: -25°C~85°C, 70%RH (Max.)
- Service life: Within the limits of six month from being produced.
- The appearance and solder ability should be check, if product is not in expiry date.

Operation Conditions

- Use condition limit: T=-25°C ~ 85°C, RH≤90%.

NOTE:

- The parts are manufactured in accordance with this specification. If other conditions and specifications which are required, please contact us for more information.
 - We will supply the parts in accordance with this specification unless we receive a written request to modify prior to an order placement.
 - In no case shall JH be liable for any product failure from in appropriate handling or operation of the item beyond the scope of this specification.
 - When changing your production process, please notify us immediately.
- V)This drawings and specifications are the property of JHcoils .and shall not be reproduced or used as this the basis for the manufacture or sale of apparatus or devices without permission.

CUSTOMED PRODUCTS

We can customize transformer bobbin your requirements.Email us:info@jhcoils.com

ATTENTION:The electronic component is designed and developed for usage in general electronic products only.This products are not specifically designed for Military, Aviation, Aerospace, Life-dependant Medical applications or any application requiring high reliability where component failure could result in loss of life and/or property. We shallnot be liable for incidental or consequential damages of any kind.

All material
meet RoHs
Standard

JHCOILS

Shijie town, Dongguan,Guangdong | CN 523290 **Revised:**
Email. info@jhcoils.com
Visit www.JHcoils.com for more design